

MICROWAVE OVEN

PRODUCT DIMENSIONS

MODEL #	KMCS522RPS	
Unit of Measurement	in	cm
Overall Width (A)	21 ³ / ₄	55.3
Overall Height (B)	12 ¹ / ₄	31.2
Height of the door (C)	11 ⁷ / ₁₆	29.1
Depth without door (D)	16 ¹¹ / ₁₆	42.4
Depth with door (E)	20 ¹⁵ / ₁₆	53.2
Depth with door open 90° (F)	37 ¹⁵ / ₁₆	96.3

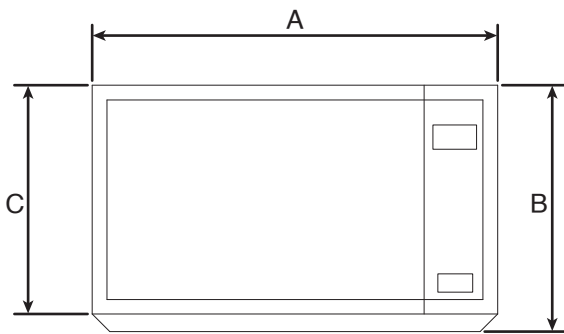

FRONT VIEW

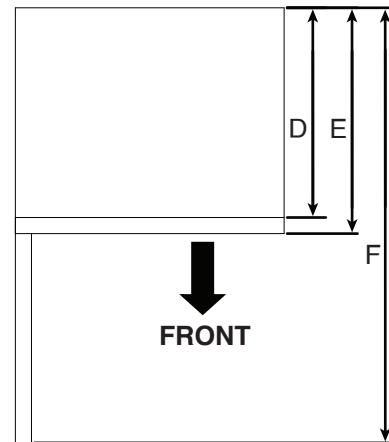

TOP VIEW

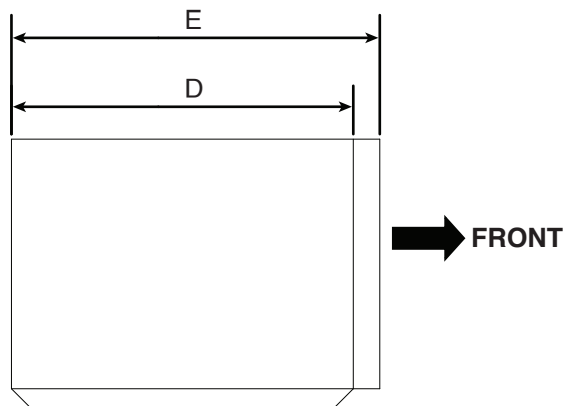

SIDE VIEW

NOTE: Specifications subject to change without notice.

MICROWAVE OVEN

MICROWAVE INTERIOR CAVITY DIMENSIONS

MODEL #	KMCS522RPS	
Unit of Measurement	in	cm
Cavity Height (A)	10 ³ / ₈	26.4
Cavity Width (B)	14 ³ / ₄	37.6
Cavity Depth (C)	16 ¹¹ / ₁₆	42.4

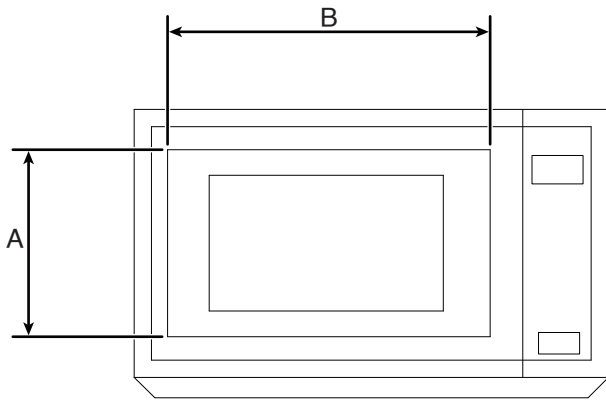

CAVITY INTERIOR FRONT VIEW

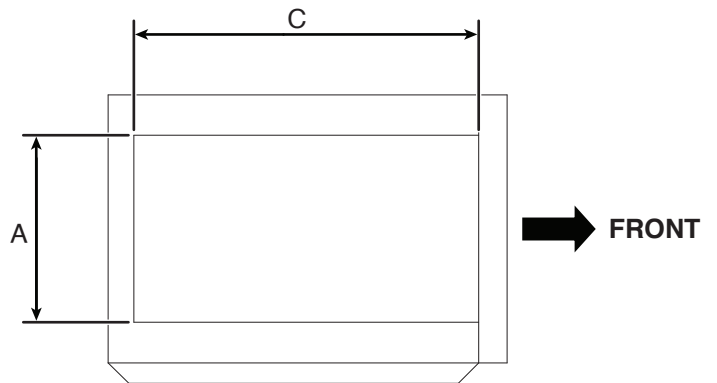

CAVITY INTERIOR SIDE VIEW

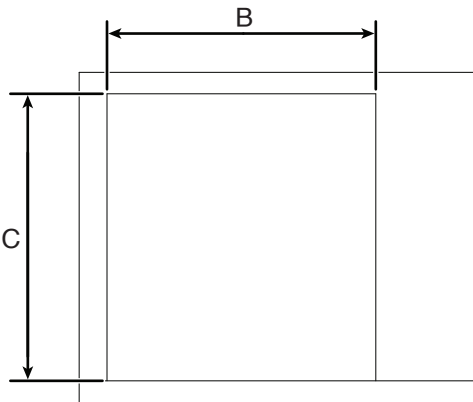

FRONT

CAVITY INTERIOR TOP VIEW

NOTE: Specifications subject to change without notice.

FOUR À MICRO-ONDES

DIMENSIONS DU PRODUIT

No De Modèle	KMCS522RPS	
Unité de mesure	po	cm
Largeur totale (A)	21 ³ / ₄	55,3
Hauteur totale (B)	12 ¹ / ₄	31,2
Hauteur de la porte (C)	11 ⁷ / ₁₆	29,1
Profondeur sans porte (D)	16 ¹¹ / ₁₆	42,4
Profondeur avec porte (E)	20 ¹⁵ / ₁₆	53,2
Profondeur avec porte ouverte à 90° (F)	37 ¹⁵ / ₁₆	96,3

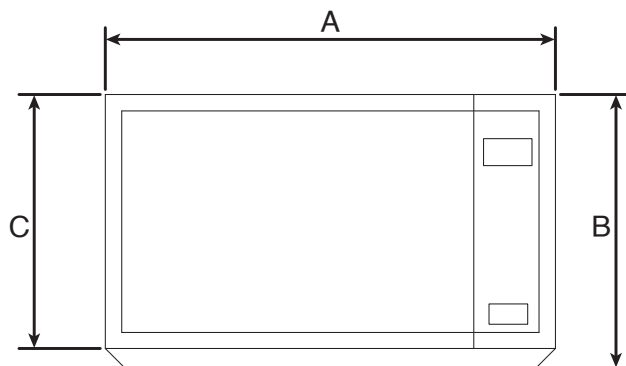

VUE DE FACE

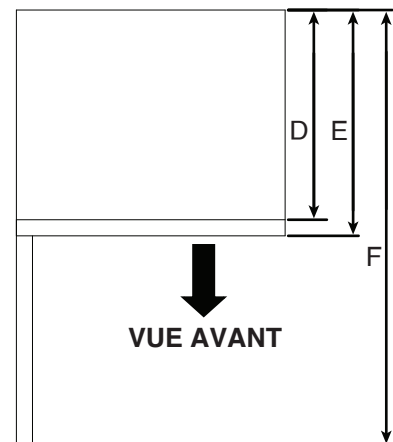

VUE DU DESSUS

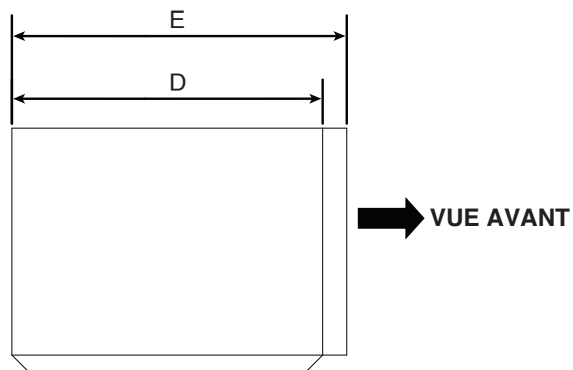

VUE LATÉRALE

REMARQUE : Spécifications sujettes à changement sans préavis.

FOUR À MICRO-ONDES

DIMENSIONS DE CAVITÉ DU FOUR À MICRO-ONDES

No De Modèle	KMCS522RPS	
Unité de mesure	po	cm
Hauteur de la cavité (A)	10 ³ / ₈	26,4
Largeur de la cavité (B)	14 ³ / ₄	37,6
Profondeur de la cavité (C)	16 ¹¹ / ₁₆	42,4

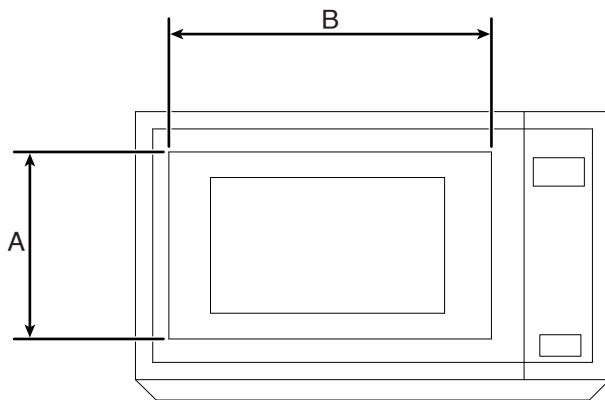

VUE AVANT INTÉRIÈRE DE LA CAVITÉ

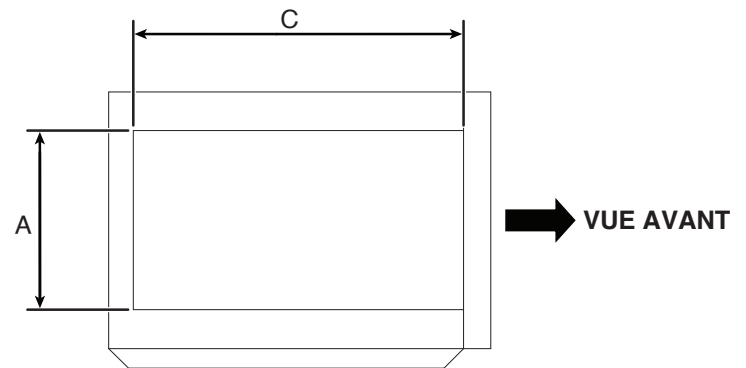

VUE LATÉRALE INTÉRIÈRE DE LA CAVITÉ

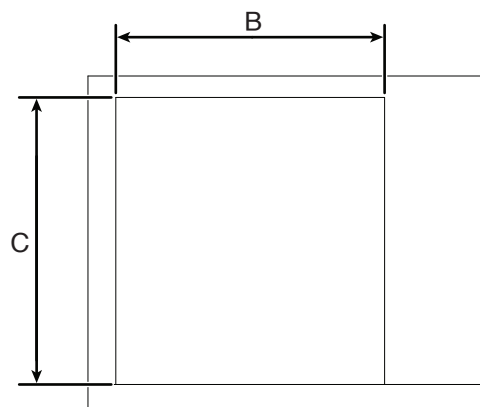

VUE AVANT

VUE DE DESSUS INTÉRIÈRE DE LA CAVITÉ

REMARQUE : Spécifications sujettes à changement sans préavis.

HORNO DE MICROONDAS

DIMENSIONES DEL PRODUCTO

Nº. De Modelo	KMCS522RPS	
Unidad de medida	pul	cm
Ancho total (A)	21 ³ / ₄	55,3
Altura total (B)	12 ¹ / ₄	31,2
Altura de la puerta (C)	11 ⁷ / ₁₆	29,1
Profundidad sin puerta (D)	16 ¹¹ / ₁₆	42,4
Profundidad con puerta (E)	20 ¹⁵ / ₁₆	53,2
Profundidad con puerta abierta a 90° (F)	37 ¹⁵ / ₁₆	96,3

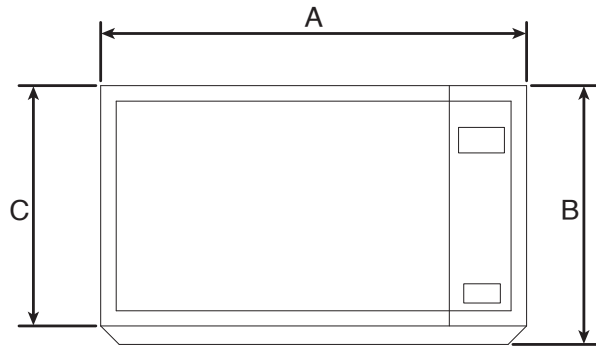

VISTA FRONTAL

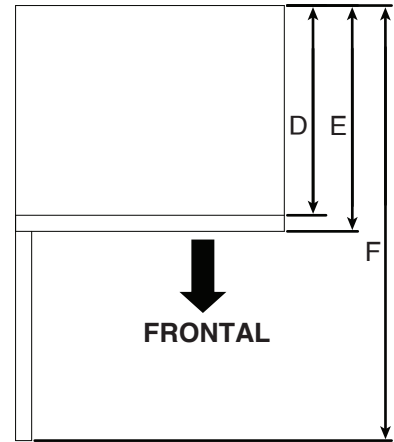

VISTA SUPERIOR

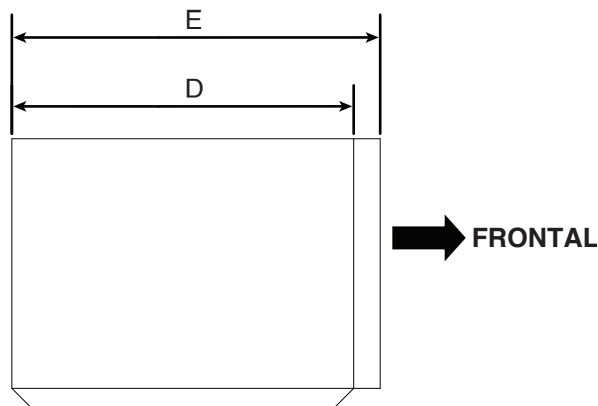

VISTA LATERAL

NOTA: Las especificaciones están sujetas a cambios sin previo aviso.

HORNO DE MICROONDAS

DIMENSIONES DE LA CAVIDAD INTERIOR DEL MICROONDAS

Nº. De Modelo	KMCS522RPS	
Unidad de medida	pul	cm
Altura de la cavidad (A)	10 ³ / ₈	26,4
Ancho de la cavidad (B)	14 ³ / ₄	37,6
Profundidad de la cavidad (C)	16 ¹ / ₁₆	42,4

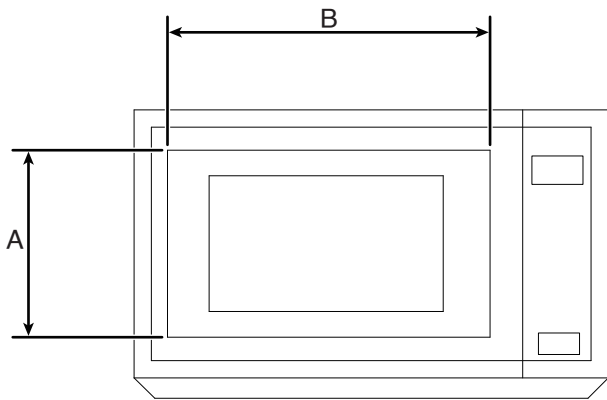

VISTA FRONTAL DE LA CAVIDAD INTERIOR

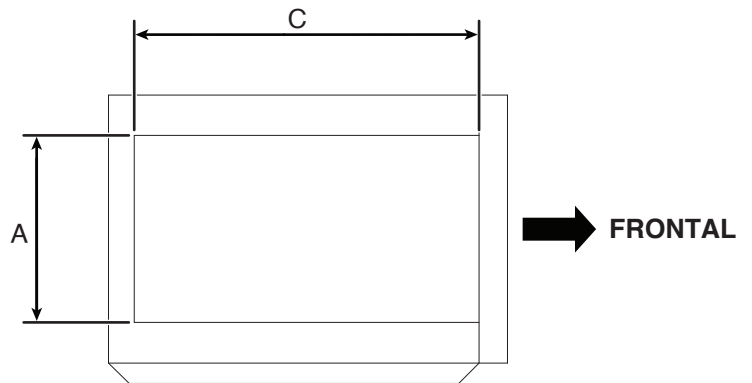

VISTA LATERAL DE LA CAVIDAD INTERIOR

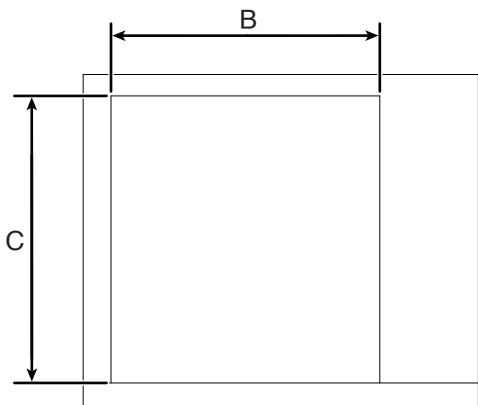

FRONTAL

VISTA SUPERIOR DE LA CAVIDAD INTERIOR

NOTA: Las especificaciones están sujetas a cambios sin previo aviso.



W11731905A
06/24

®/™ ©2024 KitchenAid. All rights reserved. The design of the stand mixer is a trademark in the U.S. and elsewhere.
Used under license in Canada.
Tous droits réservés. La forme du batteur sur socle est une marque de commerce aux É.-U. et dans d'autres pays.
Utilisé sous licence au Canada.
Todos los derechos reservados. El diseño de la batidora es una marca comercial en EE. UU. y en otros países.
Usado bajo licencia en Canadá.

KitchenAid®